



# Ropox SlimLine Electric



## User Manual

**This manual must always accompany the product**

# Table of contents

<b>1.</b>	<b>SYMBOLS USED IN THIS MANUAL.....</b>	<b>2</b>
<b>2.</b>	<b>GENERAL SAFETY.....</b>	<b>2</b>
2.1	PRODUCT UNIT LABEL.....	4
<b>3.</b>	<b>GENERAL REQUIREMENTS.....</b>	<b>5</b>
3.1	PRODUCT INFORMATION.....	5
3.2	PRODUCT DESCRIPTION.....	5
3.3	INTENDED USE.....	5
3.4	INTENDED OPERATOR.....	6
3.5	ESSENTIAL PERFORMANCE.....	6
3.6	NON-CLINICAL FUNCTIONS.....	6
3.7	CLINICAL FUNCTIONS.....	6
3.8	PRODUCT DIMENSIONS.....	6
<b>4.</b>	<b>INSTRUCTIONS FOR USE.....</b>	<b>7</b>
4.1	OPERATING THE PRODUCT.....	7
4.2	INSTALLATION INTERFACES.....	8
4.3	CONNECTION ADAPTERS.....	9
4.4	LIST OF COMPONENTS.....	10
4.5	ACCESSORIES.....	11
4.6	INSTALLATION OF PRODUCT.....	13
4.6.1	Functionality test.....	26
4.7	CABLE DIAGRAMS.....	26
<b>5.</b>	<b>TROUBLE SHOOTING.....</b>	<b>27</b>
<b>6.</b>	<b>SAFETY IN USE.....</b>	<b>27</b>
<b>7.</b>	<b>CLEANING.....</b>	<b>28</b>
7.1	PREAPPROVED CLEANING AGENTS.....	28
<b>8.</b>	<b>MAINTENANCE.....</b>	<b>28</b>
8.1	PERFORMANCE TEST.....	28
8.2	SERVICE SCHEDULE.....	29
<b>9.</b>	<b>SPARE PARTS LIST.....</b>	<b>30</b>
<b>10.</b>	<b>ENVIRONMENTAL PROTECTION.....</b>	<b>31</b>
<b>11.</b>	<b>ELECTROMAGNETIC COMPATIBILITY.....</b>	<b>31</b>
11.1	SUITABLE ENVIRONMENTS.....	31
11.2	ADJACENT AND STACKED USE.....	31
11.3	CABLES.....	31
11.4	RF PORTABLE EQUIPMENT.....	31
<b>12.</b>	<b>COMPLAINTS.....</b>	<b>32</b>

# 1. Symbols used in this manual

<b>Warning Symbol</b> Indication of potentially hazardous situation. If not avoided, it can result in serious injury or death.	
<b>Caution Symbol</b> Indication of potentially hazardous situation which may result in minor or moderate injury. It may also be used to alert against unsafe practices.	
<b>Notification Symbol</b> This symbol is used to notify correct use and handling of the product.	

## 2. General safety

	<p>This manual must be read and understood before use. Always keep this manual in close proximity of the product.</p> <p>The use, installation and service of this product must be in compliance with this manual to avoid accidents and serious personal injury.</p> <p>Never use or handle this product in other ways specified in this manual as it can result in personal safety hazards and/or cause damage to the product.</p> <p>Persons installing and/or using this product either as operator or user should have the necessary safety information and access to this manual.</p> <p>If the supply cord is damaged, it must be replaced by the manufacturer, its service agent or similarly qualified designated persons in order to avoid a hazard.</p>
--	--



Do not perform repairs, disassembly or assembly operations, add-ons, re-adjustments or modification of the product beyond what is described in this manual. These must be carried out by Ropox or Ropox authorized personnel. Do not perform service while in use.

This appliance can be used by children aged from 8 years and above and persons with reduced physical, sensory or mental capabilities or lack of experience and knowledge if they have been given supervision or instruction concerning use of the appliance in a safe way and understand the hazards involved. Children shall not play with the appliance. Cleaning and user maintenance shall not be made by children without supervision.

Do not use the product if it has defects or have become damaged before being repaired or replaced.  
If the control box makes unusual noise or smells, switch off the mains voltage immediately.

Take care that the cables are not damaged.

Unplug the mains cable on mobile equipment before it is moved.

The products must only be used in an environment that corresponds to their IP protection.



The information in this manual is based on correct installation in accordance with installation instructions for this product.

Ropox cannot be held liable if the product is used in any way that differs from stated in this manual and/or installation instruction.

Ropox reserve the right to amend this manual and reference documents without prior notice.

## 2.1 Product Unit label



	This product is UKCA-marked in accordance with: UK SI 2002 No. 618 - <i>The Medical Devices Regulations 2002</i> , and its amendments
	This product is CE-marked in accordance with: European Medical Device Regulation (EU)2017/745 Council Directive 2011/65/EU, RoHS
	Manufacturer name and address
	Date of production
	Stock number
	Serial number
	Operating interval of electrically operated equipment. The use of electrical height adjustable equipment can run at maximum 2 minutes, followed by an 18-minute break.
	Type BF applied part. The product complies with IEC 60601-1 requirements to provide protection against electric shock.
	Consult manual for important safety related information, warnings and safety precautions.
	Class II, double isolated electrical components.
	Do not dispose as unsorted municipal waste. Product must be returned to a designated recycling station.
	Mobile phones or other portable RF emitting equipment should be no closer to the product than 30cm.
	Operating and storing temperatures may not exceed 5-40°C°
	Consult manual before use

## 3. General requirements

### 3.1 Product information

<b>Manufacturer</b>	<b>Ropox A/S</b> Ringstedgade 221 DK-4700 Naestved +45 55 75 05 00 <a href="mailto:Info@ropox.com">Info@ropox.com</a>	<b>UK Responsible Person</b>	<b>Qserve Group UK, Ltd</b> 49 Greek Street, W1D 4EG London United Kingdom +44 740 885 936 3 <a href="mailto:info@qservegroup.com">info@qservegroup.com</a>
<b>Product models</b>	<b>Part number</b>	<b>Model</b>	<b>Configuration</b>
	40-15607	SlimLine	Unit
<b>Expected service life</b>	5 years		
<b>MDR Class 2017/745</b>	<b>Class I</b>		
<b>Applied part classification 60601-1</b>	<b>Type BF</b> applied part		
<b>MEE Class 60601-1</b>	<b>Class II</b>		
<b>Height adjustment</b>	70-100cm		
<b>Maximum user weight according to DS/EN 17966:2016</b>	40-15607	Unit	200kg
	40-15621	WBR-200	165kg
	40-15627	WBR-201	165kg
	40-15623/40-15633	WBR-100	200kg
	40-15624/40-15634	WBR-101	200kg
	40-15625/40-15635	WBR-102	200kg
	40-15626/40-15636	WBR-103	200kg
<b>Power supply</b>	230V ~50Hz		
<b>I in</b>	Max 2.5A		
<b>Intermittence</b>	2min use / 18min pause		
<b>IP rating</b>	IPX6		
<b>Ambient temperature range</b>	-10 °C to +50 °C Transport and storage +5 °C to +45 °C Operation		
<b>Relative humidity:</b>	20% to 80% - non-condensing		
<b>Intended environments</b>	This product is to be used only in:  Professional Healthcare Environment Homecare Environment  <i>The device is not intended for use in special environments as defined by IEC 60601-1-2</i>		
<b>Materials in contact with patient</b>	Cover plate	Vacuum-formed acrylic glass	
<b>Accessories</b>	40-15631 40-15632 40-40935 40-15640 40-44040 40-44039	Fixed Control, Right Fixed Control, Left Plug with Overflow Soap Dispenser Bracket Oras Saga 3910F Oras Clinica 5611B	

### 3.2 Product description

The height-adjustable SlimLine unit is characterized by the elegant and slim design that combines mirror and washbasin into one solution. Ranging from 70-100cm in height adjustment, it offers excellent access for both standing and seated users. In addition, it is designed with plenty of legroom underneath the sink, allowing wheelchair users to come close to the washbasin and within easy reach of the mixer tap.

### 3.3 Intended use

The SlimLine washbasin combines mirror and basin in one unit, and the mirror is therefore always at the right height no matter if you are sitting in a wheelchair or standing up.

### 3.4 Intended operator

Reading and understanding this manual will be sufficient training for an intended operator. Children under the age of 16 or patient are not considered intended operator.

### 3.5 Essential Performance

The product does not have essential performance, as the patient and user do not experience any risk in case of loss of product function/performance.

### 3.6 Non-clinical functions

Height adjusting offers better ergonomics to the user.

### 3.7 Clinical functions

The product does not have any clinical functions.

### 3.8 Product dimensions

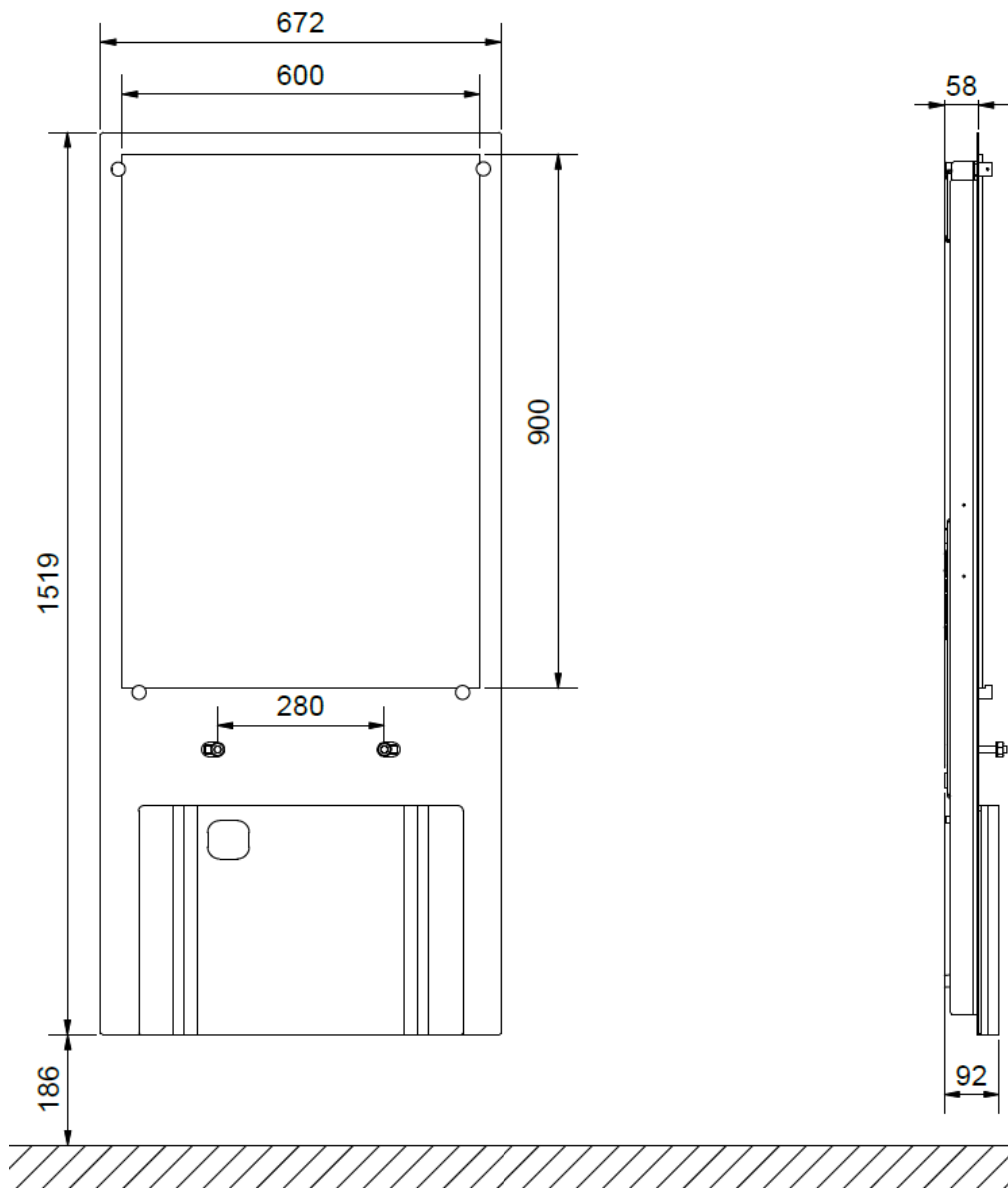

All dimensions in mm

## 4. Instructions for use

### 4.1 Operating the product

Ropox SlimLine is adjusted in height by using either the fixed control, or the hand control with spiral cable. This ensures an optimal height for washing your hands, aiding users and carers alike.

Ropox SlimLine is NOT for use as a lifting table or person lift.

#### Standard Control with cable

The height of the basin can be adjusted with the control up or down.

^ adjusts the basin upwards.

∨ adjusts the basin downwards.

The basin stops moving as soon as the button is released.

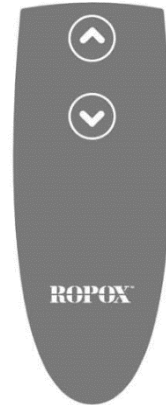

#### Fixed Control in basin (accessory)

The fixed control can be purchased as an option. The control is mounted in the washbasin itself, but it is not for after-mounting. It can only be supplied for the following washbasins – WBR-100, WBR-101, and WBR-103 (see section 4.5 Accessories).

^ adjusts the basin upwards.

∨ adjusts the basin downwards.

The basin stops moving as soon as the button is released.



#### Warning!

The product should always be able to travel the full range of actuation without colliding with objects. Failing to do so will compromise the product stability and introduce risk of squeezing body parts.

Special care should be taken in ensuring that no children or adults are sited under the product as severe injury from entrapment may occur.



## 4.2 Installation interfaces

### Construction

The wall must be made of a material suited for screw mounting and approved for damp rooms. The hatched area is the minimum area for reinforcement of the wall.

Tested in accordance with DS/ISO 17966:2016 with the following max. user weights:

40-15607: 200kg / 440 lbs (when using a porcelain wash basin)

40-15621: 165kg / 363 lbs

40-15627: 165kg / 363 lbs

40-15623/40-15633: 200kg / 440 lbs

40-15624/40-15634: 200kg / 440 lbs

40-15625/40-15635: 200kg / 440 lbs

40-15626/40-15636: 200kg / 440 lbs

### Max. tensile load of upper screws

68kg/screw (150 lbs)

The washbasin is supplied with a set of screws and rawplugs suitable for mounting on a concrete wall. The fitter should always consider the material, condition and strength of the wall and use screws and rawplugs suitable for the specific wall type.

### Plumbing

The drain is  $\varnothing 32$  (1 1/4") and ends in an  $\varnothing 32 \times 88.5^\circ$  drain elbow.

The water supply ends in 2 (two) 90° shut-off valves with 1/2" outside thread pointing downwards in an angle of 45° (not included). The maximum protrusion of the shut-off valves and drain connection should be max 77mm (3") to allow for the covers.

The optimum location and orientation are as shown. It is important that all hoses for water connection and drain are flexible to allow the frame to move freely within the height-adjustment range of 700-1000mm (27 1/2" – 39 2/5") (including washbasin). If a different location of water supply from the recommended positioning is required and if there is a floor drain, the installation cover (40-15610) can't be used.

For purchase of adapters for connection to various standard installations, see "Connection Adapters – Other Washbasins".

### Power

Recommended location of socket in wall for optimum and hidden wiring is above unit as shown. The cable from the control unit is 2000mm (78").

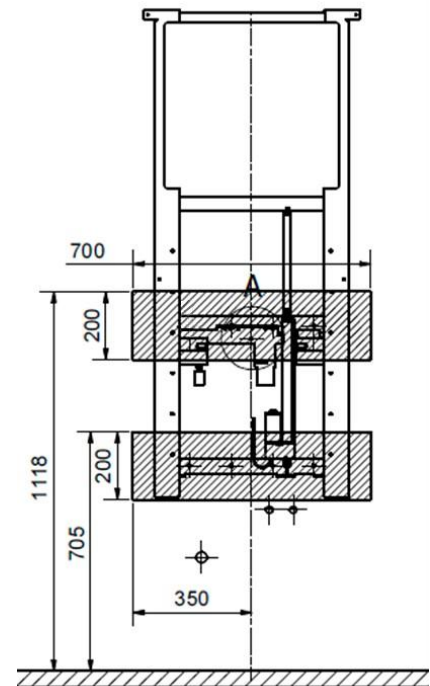



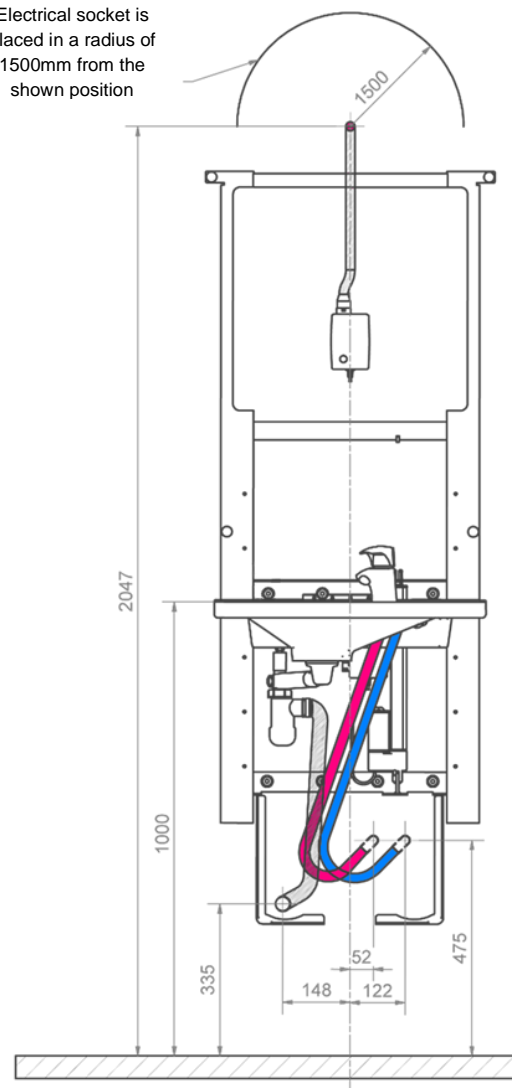



Electrical socket is placed in a radius of 1500mm from the shown position







### 4.3 Connection adapters

If the recommendations cannot be met, the components described below may be ordered. Ropox is not responsible for the optimal functionality of the below components under covers when adjusting the height of the unit.







#### Water connection adapters

Hoses from washbasin	Adapter	Installation in room (not included)
 1/2"	No adapter needed	 1/2" Thread
	 1/2" -> 3/8" Item no. 97001670	 3/8" Thread
	 1/2" -> 15mm Item no. 97001666	 15mm Pipe





#### Water hose extensions

Hose from washbasin	Coupling piece	Extra hose
	 1/2" -> 1/2" Item no. 97001662	 1/2" x 1/2", 0.5m, steel Item no. 97001123
		 1/2" x 1/2", 1m, plastic Item no. 97001120













#### Drain adapters

Drain from washbasin	Adapter	Installation in room (not included)
 Ø32	No adapter needed	 Ø32
	 Ø32 -> Ø40 Item no. 97001660	 Ø40
	 Ø32 -> Ø50 Item no. 97001661	 Ø50

#### Drain extensions







Drain hose from washbasin	Coupler	Extra drain hose
 Ø32	 Ø32-Ø32 Item no. 97001662	 Ø32 Flex hose, 40-110cm Item no. 97001161
		 Ø32 Flex hose, 27-62cm Item no. 97001162

## 4.4 List of components

<b>40*15601-104</b>	<b>Lifting unit</b>	1x	
<b>97002455</b>	<b>Mirror 600x900x5</b>	1x	
<b>40*15601-097</b>	<b>Cover top</b>	1x	
<b>40*15601-096</b>	<b>Cover bottom</b>	1x	
<b>40-15610</b>	<b>Installation cover</b>	1x	
<b>97002971</b>	<b>Velcro with tape</b>	2x	
<b>97002672</b>	<b>Control box</b>	1x	
<b>97002679</b>	<b>Power supply</b>	1x	
<b>97002681</b>	<b>AC cable 2m</b>	1x	
<b>40-15630</b>	<b>Hand control with spiral cable</b>	1x	
<i>Incl.</i>			
97002689	Hand control with spiral	1x	
14141-020	Holder for hand control	1x	
96000165	Strips	3x	
96000155	Cable holder	3x	
<b>40-15612</b>	<b>Plumbing kit SlimLine</b>	1x	
<i>Incl.</i>			
97001601	Prevex siphon	1x	
97001162	Flexible drain hose Ø32/32 pipe	1x	
97001035	32x88,5° white PP Wafix elbow HT	1x	
97001136	Connection hose 700mm, Lindner	2x	
97001605	Prevex 100mm extension	1x	
95091070	Plate screw Ø4,8x70 cross recess A2	1x	
97001008	Basin plug chain	1x	
<b>97001135</b>	<b>Connection hose 17cm</b>	2x	
<b>40*15601-100</b>	<b>Mounting parts SlimLine frame</b>	1x	
<i>Incl.</i>			
95027578	Frame screw 7,5x72 stainless	8x	
95027576	Zebra "shark" dowel 10x61	8x	
95125035	Chipboard screw 5x35	3x	
40-44170-1	Mirror bracket	1x	
96000170	Strips black 4,8/290mm	4x	
40*15601-113	Mounting bracket	1x	
95061299	Bolt M12x100	2x	
97001467	Mounting parts for basin	1x	
40*15601-095	Spacer	8x	
95020521	CSK INSEX screw M5x20	4x	

## 4.5 Accessories

<p><b>40-15621</b> (Ceramic)</p>	<p><b>WBR-200</b> (With overflow)</p>	<p>1x</p> 
<p><b>40-15627</b> (Ceramic)</p>	<p><b>WBR-201</b> (No overflow)</p>	<p>1x</p> 
<p><b>40-15623</b> (Composite)</p> <p>Or</p> <p><b>40-15633</b> (Composite)</p>	<p><b>WBR-100-1</b> (No overflow)</p> <p><b>WBR-100-2</b> (With overflow)</p>	<p>1x</p> 
<p><b>40-15624</b> (Composite)</p> <p>Or</p> <p><b>40-15634</b> (Composite)</p>	<p><b>WBR-101-1</b> (No overflow)</p> <p><b>WBR-101-2</b> (With overflow)</p>	<p>1x</p> 
<p><b>40-15625</b> (Composite)</p> <p>Or</p> <p><b>40-15635</b> (Composite)</p>	<p><b>WBR-102-1</b> (No overflow)</p> <p><b>WBR-102-2</b> (With overflow)</p>	<p>1x</p> 
<p><b>40-15626</b> (Composite)</p> <p>Or</p> <p><b>40-15636</b> (Composite)</p>	<p><b>WBR-103-1</b> (No overflow)</p> <p><b>WBR-103-2</b> (With overflow)</p>	<p>1x</p> 

40-44040	Oras Saga 3910F	1x	
40-44039	Oras Clinica 5611B	1x	
40-40935	Plug with Overflow	1x	
40-15640	Bracket for Soap dispenser	1x	
40-15631	<b>Fixed Control, Right</b> <i>(Only for WBR-100, WBR-101 or WBR-103)</i>	1x	
40-15632	<b>Fixed Control, Left</b> <i>(Only for WBR-100, WBR-101 or WBR-103)</i>	1x	

## 4.6 Installation of product



### Warning!

The fitter should always consider the material, condition and strength of the wall and use screws and rawplugs suitable for the specific wall type.

Prior to the installation, make sure that all parts have been provided in accordance with the list of components.

The maximum tensile load of the screws is 68 kg. The wall must be able to resist such tensile load.

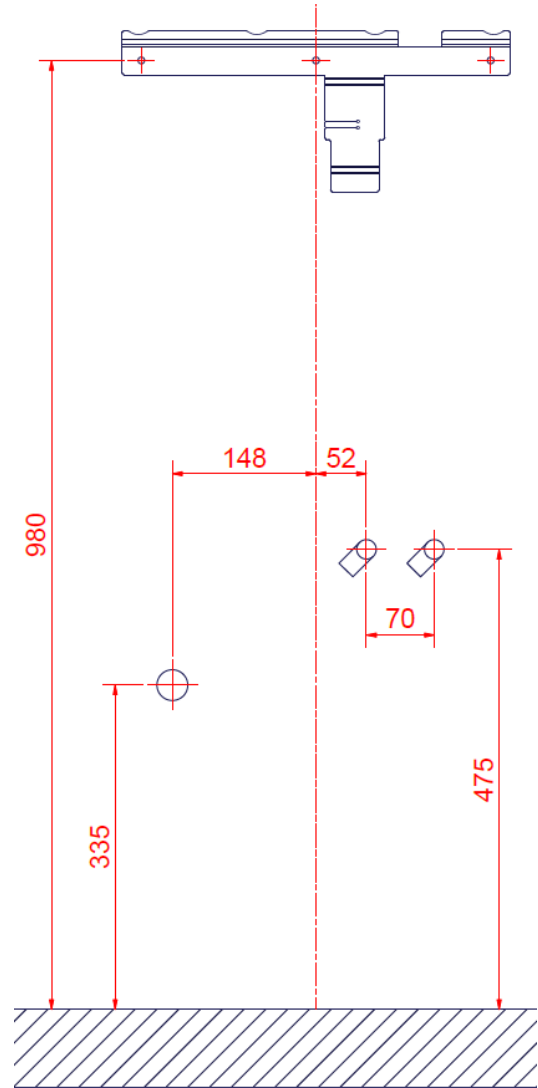
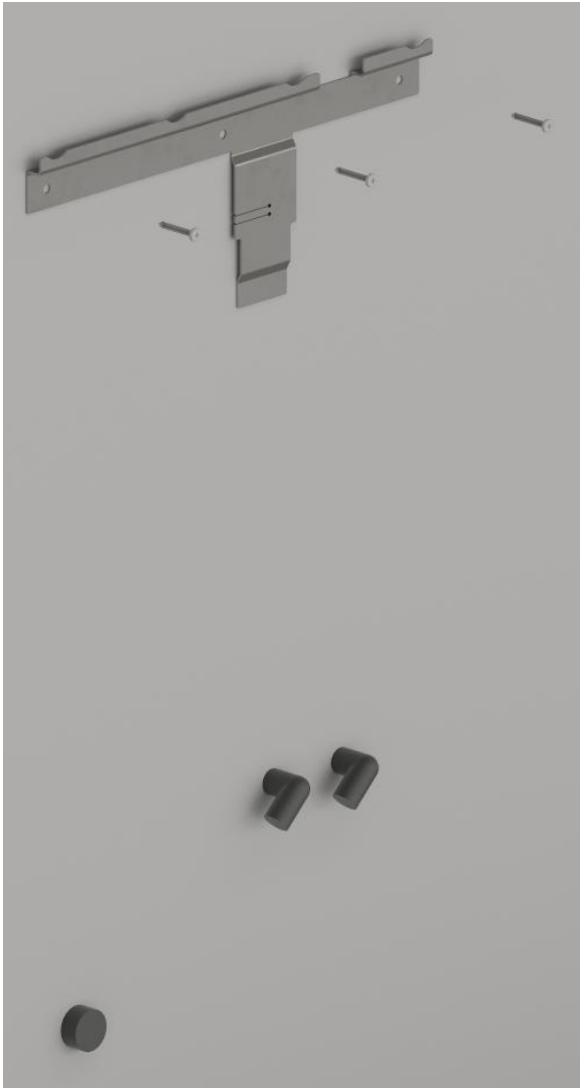

Fix the mounting bracket as illustrated on the drawing with the right distance to water and drain.  
Make sure that the mounting bracket is level.

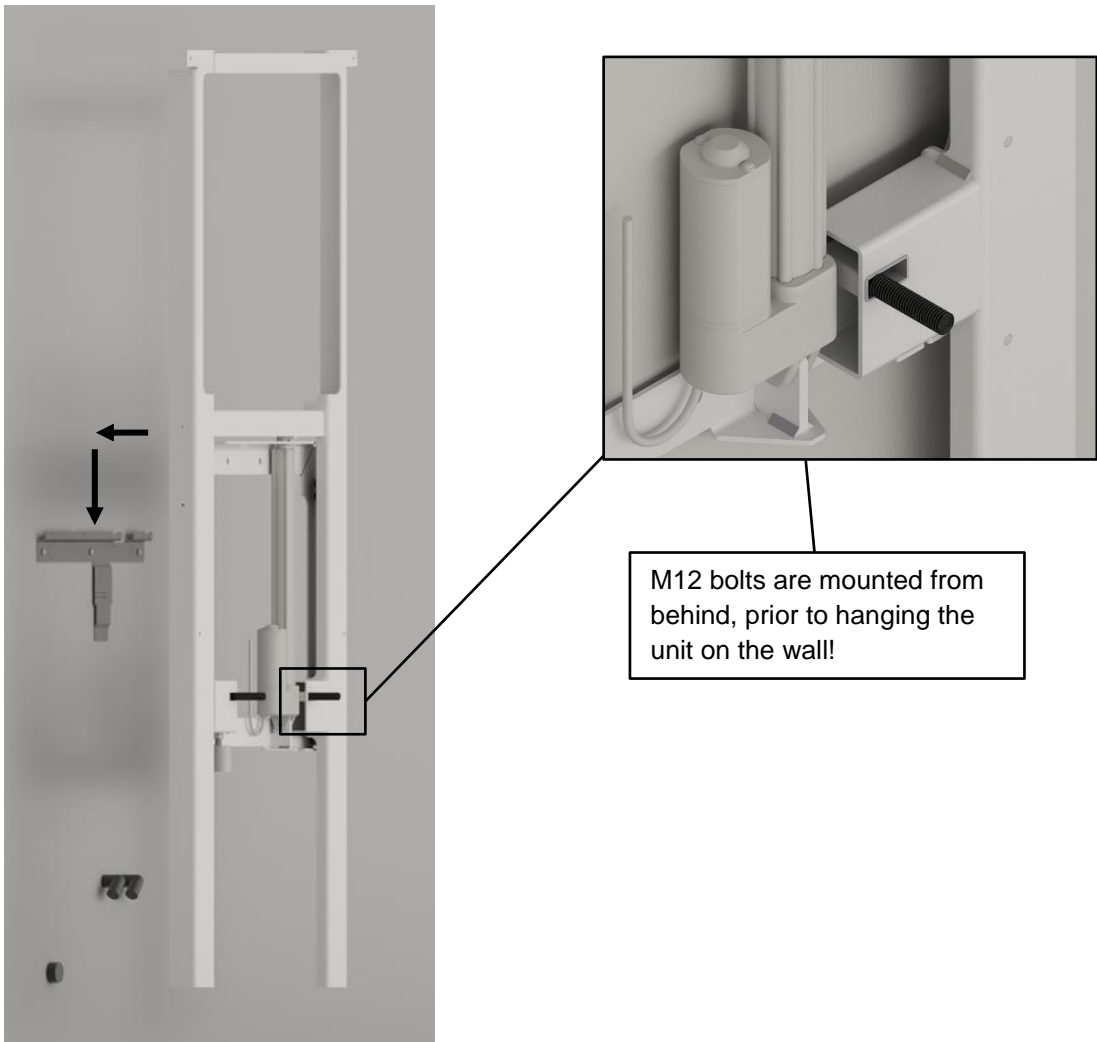

Hang the lifting unit on the mounting bracket.  
**Make sure** to put the M12 bolts for the washbasin in the frame prior to mounting.

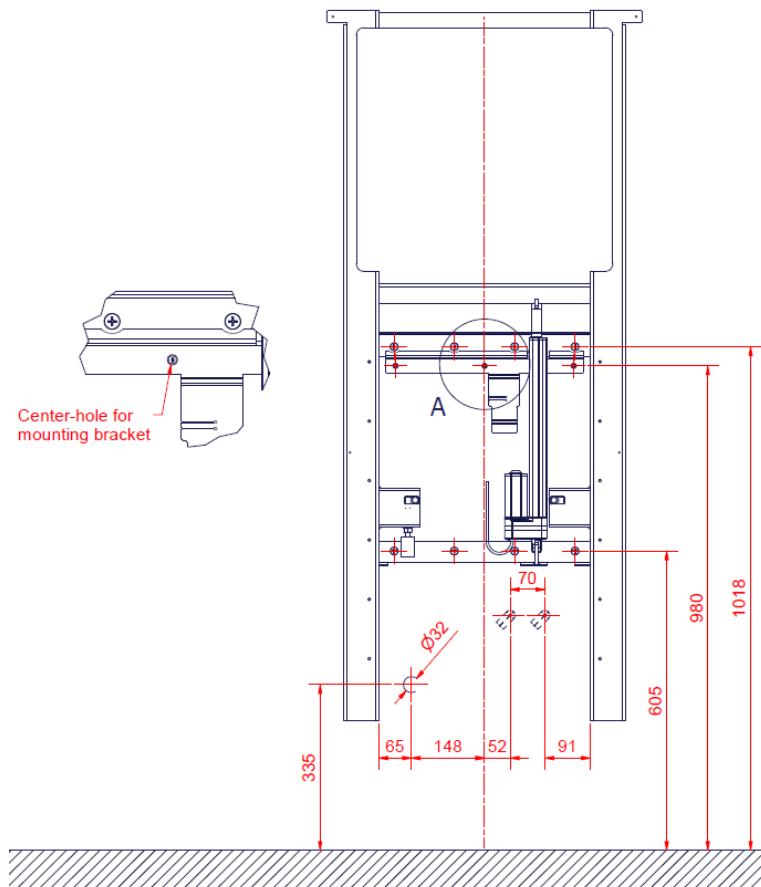

Place the unit in accordance with the water connection and drain as shown on the drawing.

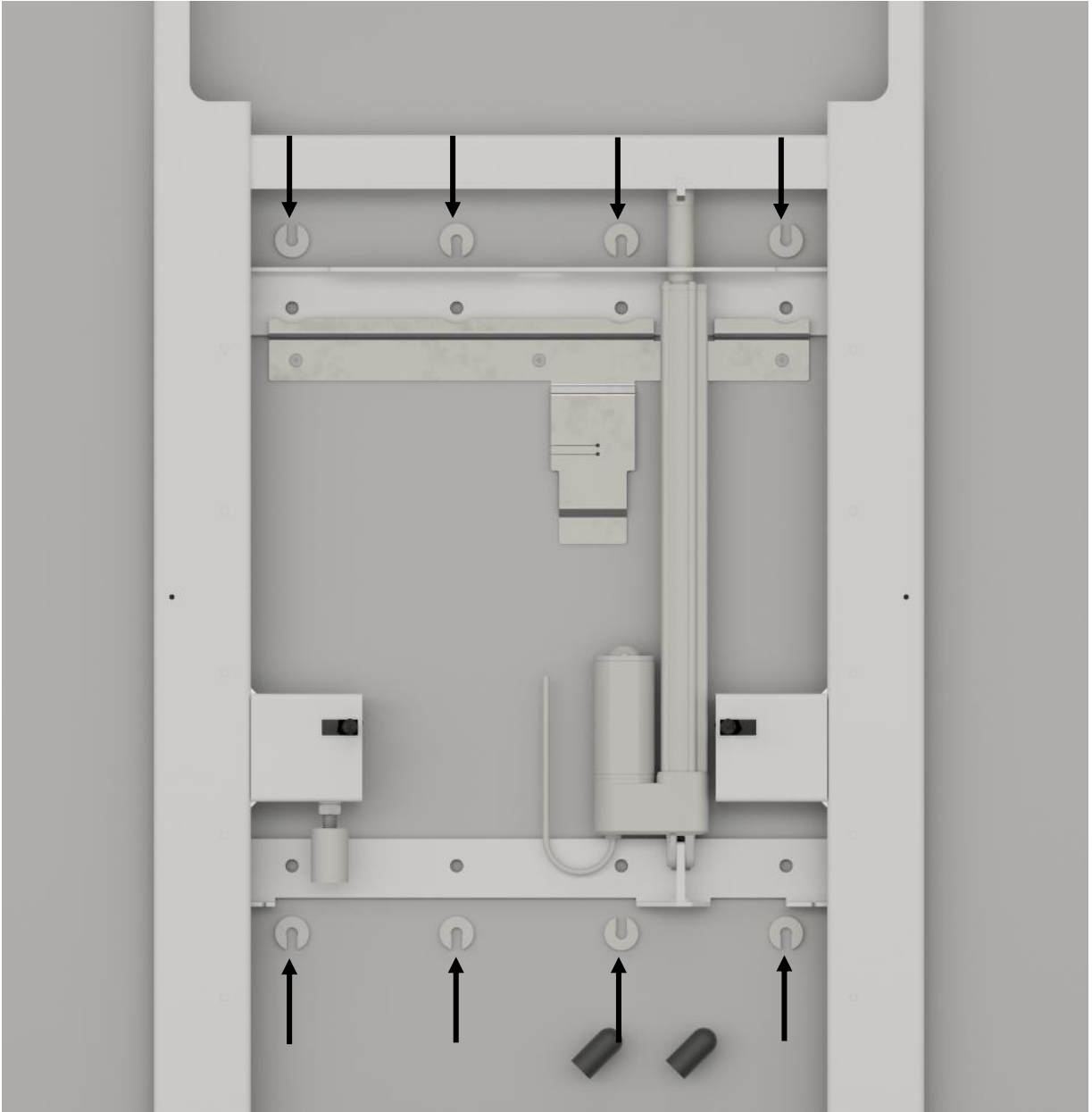

Push 8 spacers in behind the frame so that it has the right distance to the wall. Mark the 8 holes for fastening. Take the lifting unit down again and drill the holes in the wall.



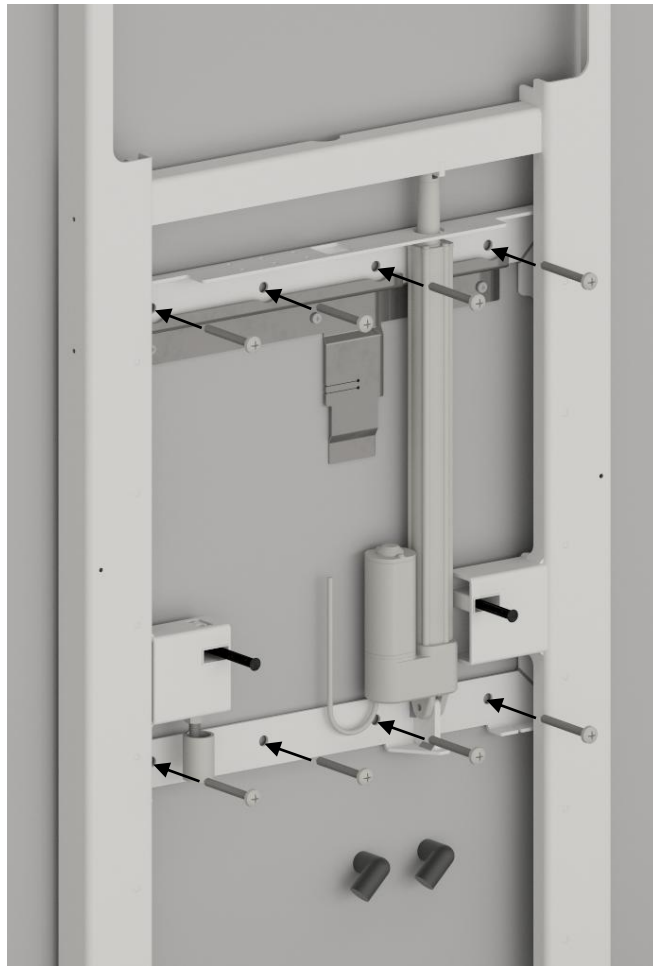

Use suitable rawplugs and screws for the mounting.

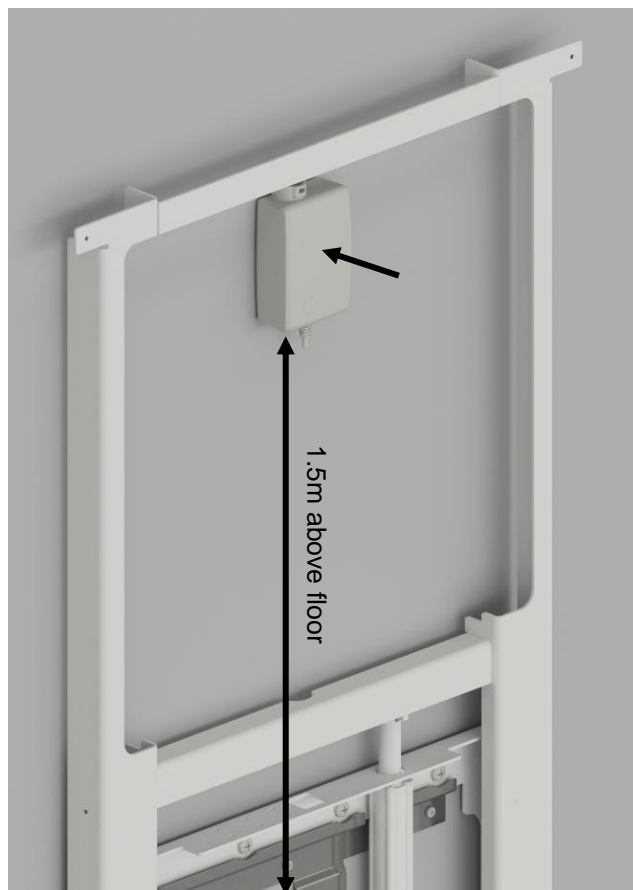

Remove the protective foil on the tape and fasten the power supply above the unit. Place it 1.5 m above the floor measured to the underside. Place it in the middle of the lifting unit.

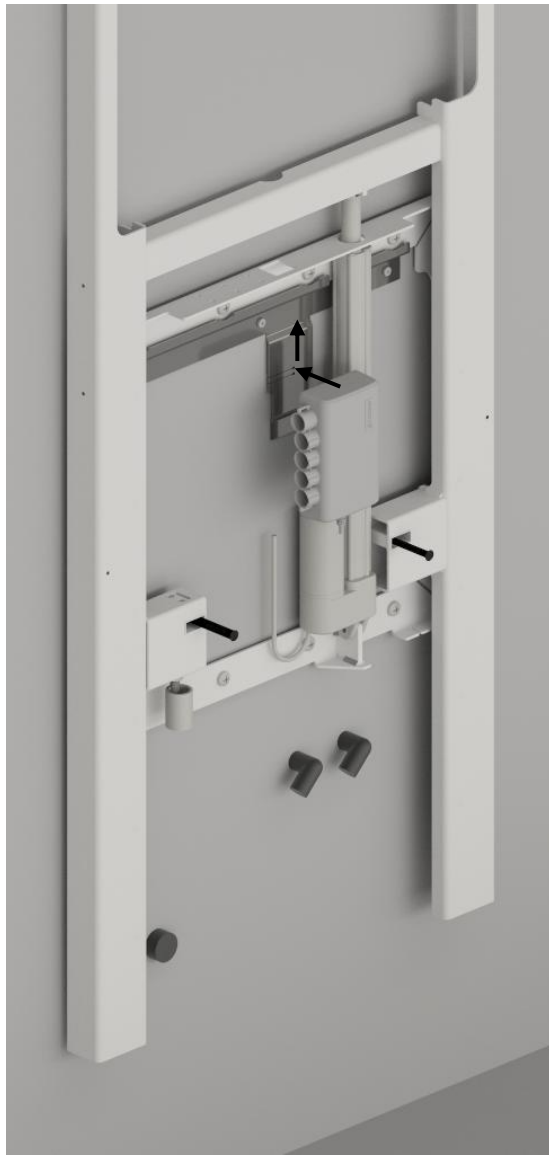

Mount the control box on the mounting bracket. Make sure that the small aluminum leg interlocks and locks the box in a fixed position.

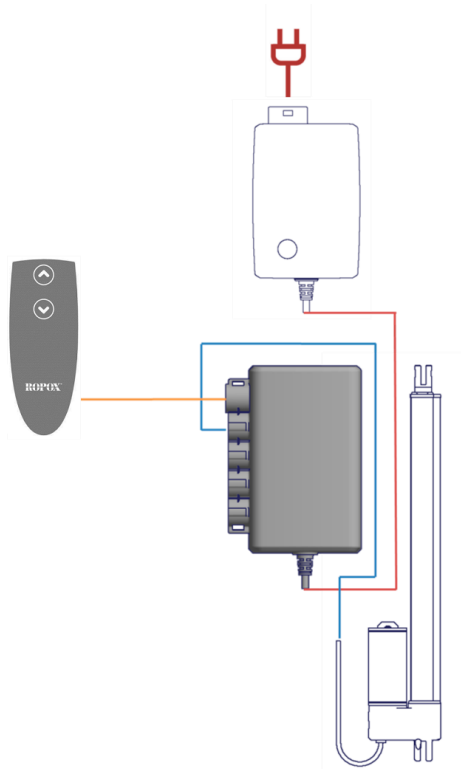

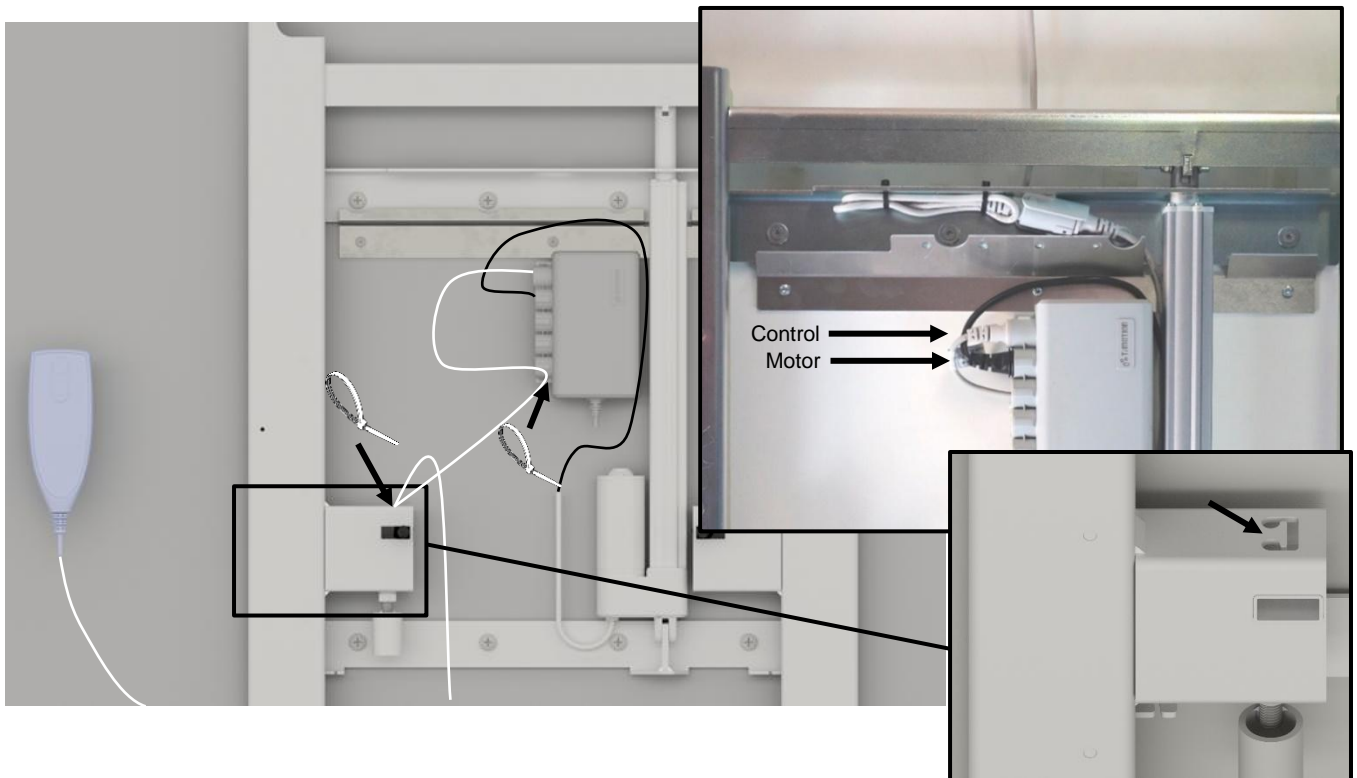

If no fixed control has been chosen, mount the control with cable in the control box as shown.  
 Fix the excess cable from the power supply on the mounting bracket with strips.  
 Check that the unit freely moves up/down. If needed, use cable clips etc. for the power cable.

The control can be mounted on the hanger that has been supplied. The hanger is mounted by removing the paper from the tape, then sticking it to the surface of choice.



It's recommended to lead the cable and fix it as shown, after the covers and washbasin has been mounted. The control cable is fixed to the mounted cable holder. Ensure the cable can reach at least 1 meter from the last cable holder when extended.

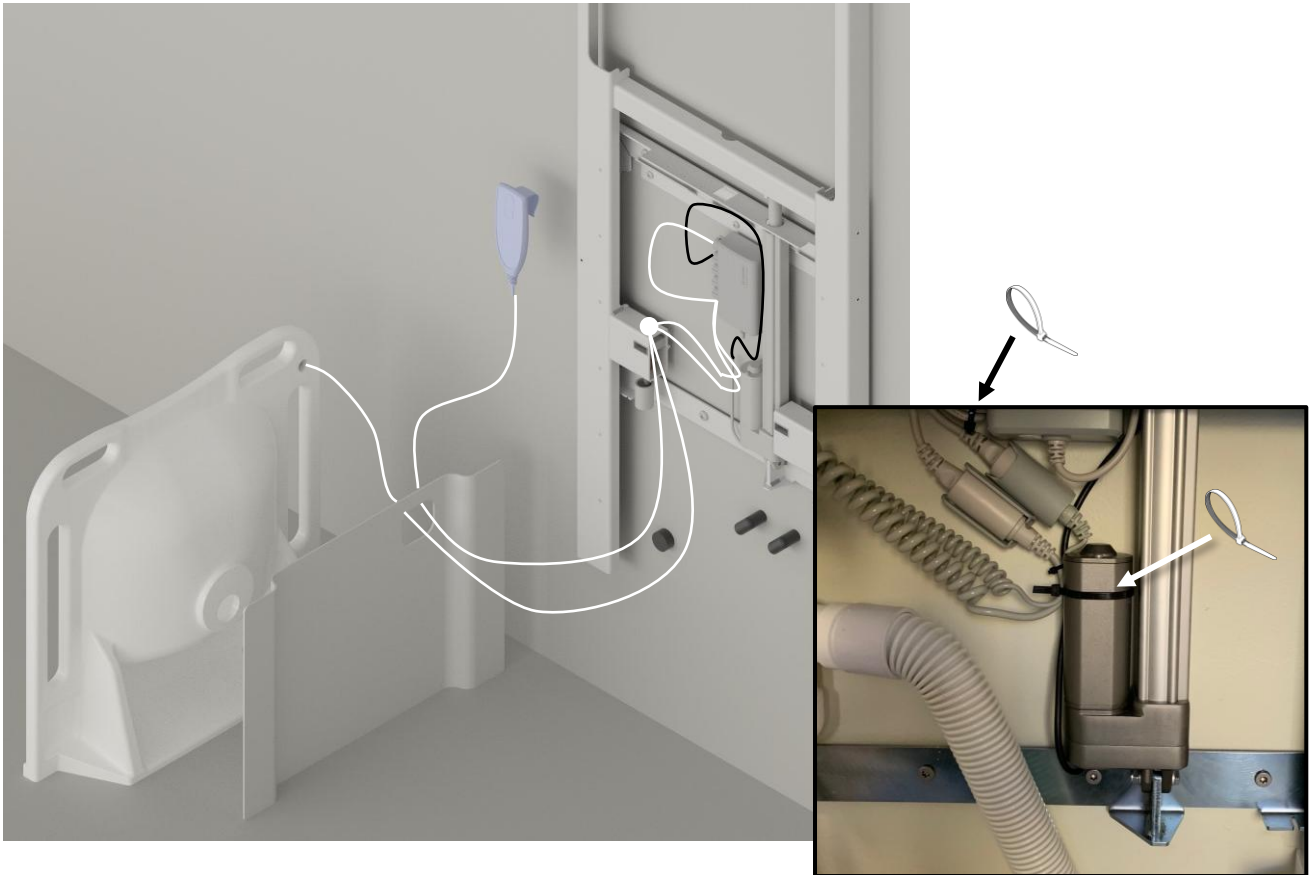

If the fixed control has been purchased as an accessory, mount the Y-cable in the control box, then lead the wires as shown. The wires should be pulled through the outer cover, for the best possible wiring. Fix the excess cable from the power supply on the mounting bracket with strips.

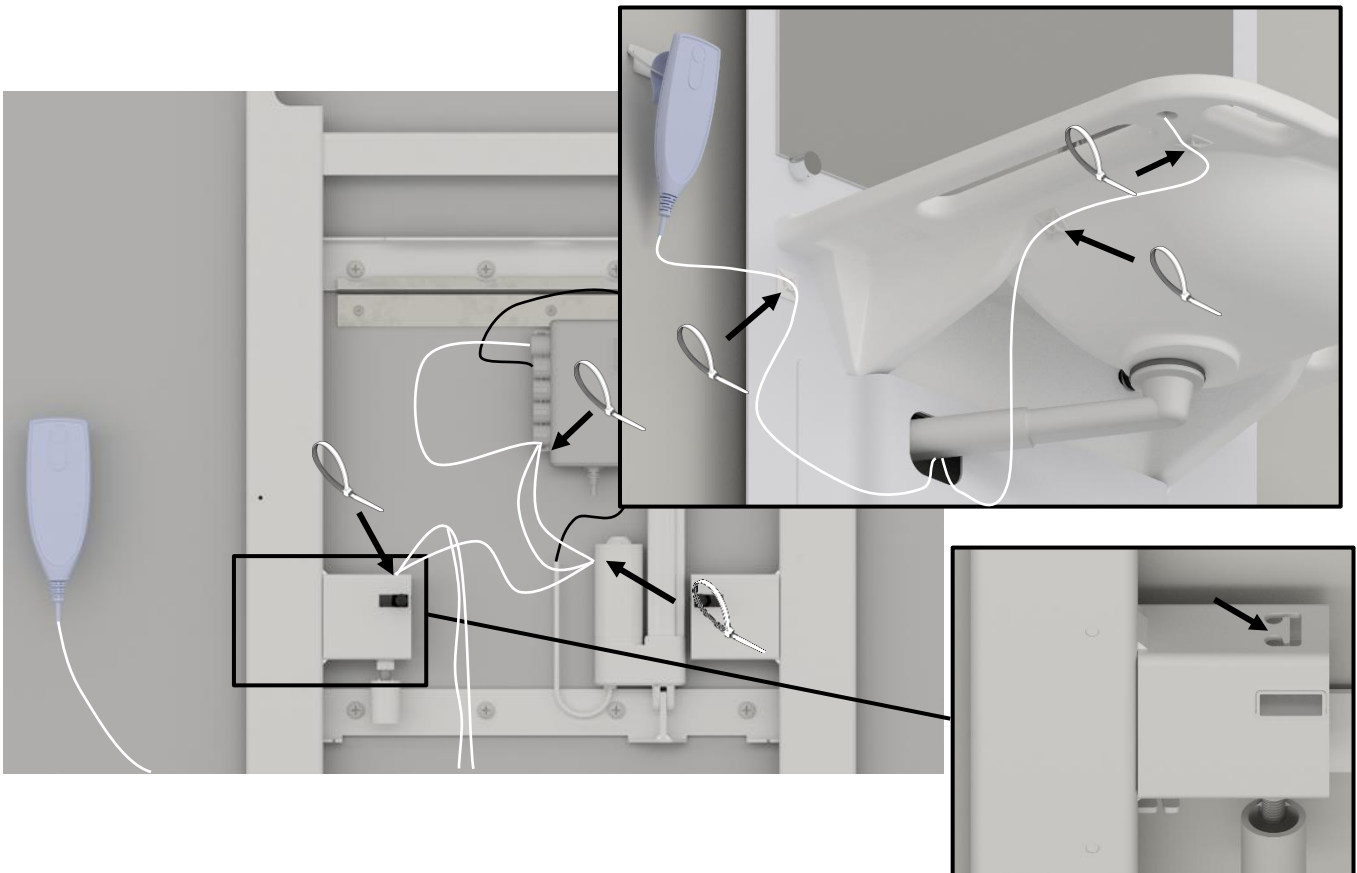

For the fixed control, it's recommended to lead the cables and fix them as shown, after the covers and washbasin has been mounted. The control cables are fixed to the mounted cable holders.

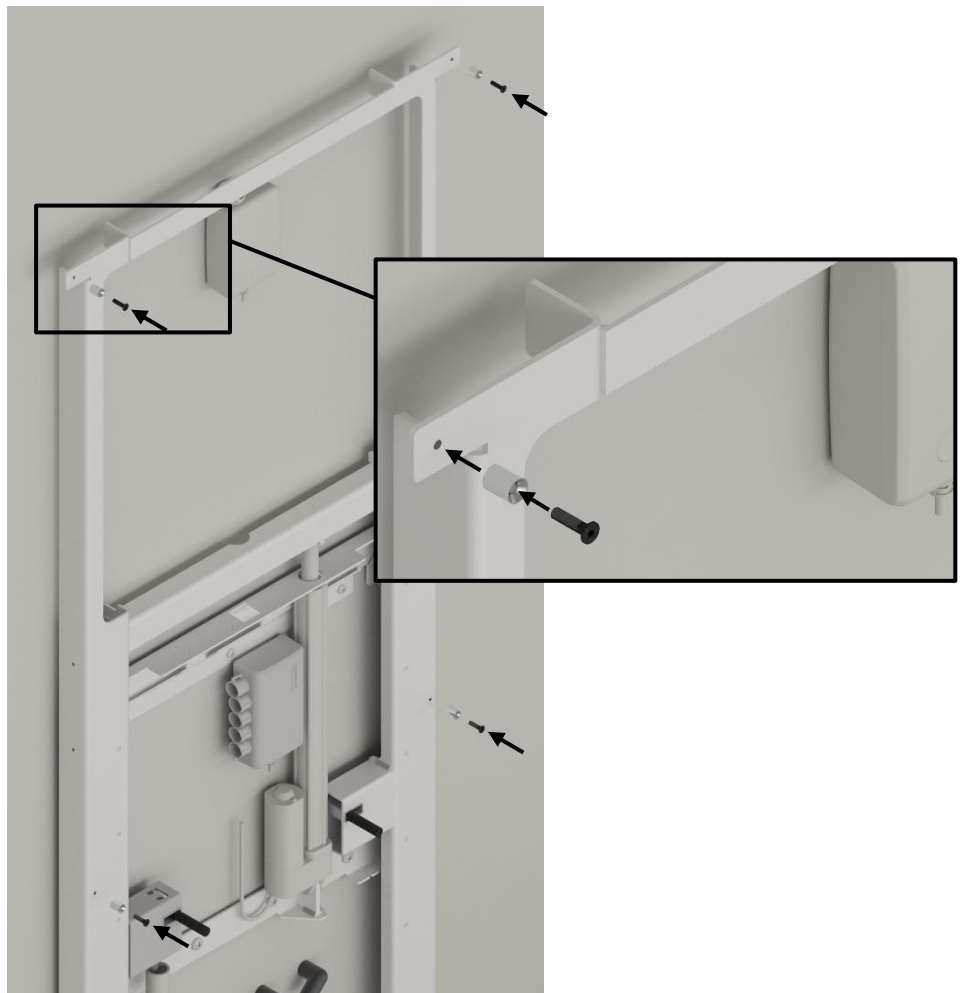

Fix the rods for the mirror bracket in the frame with M5 countersunk screws.

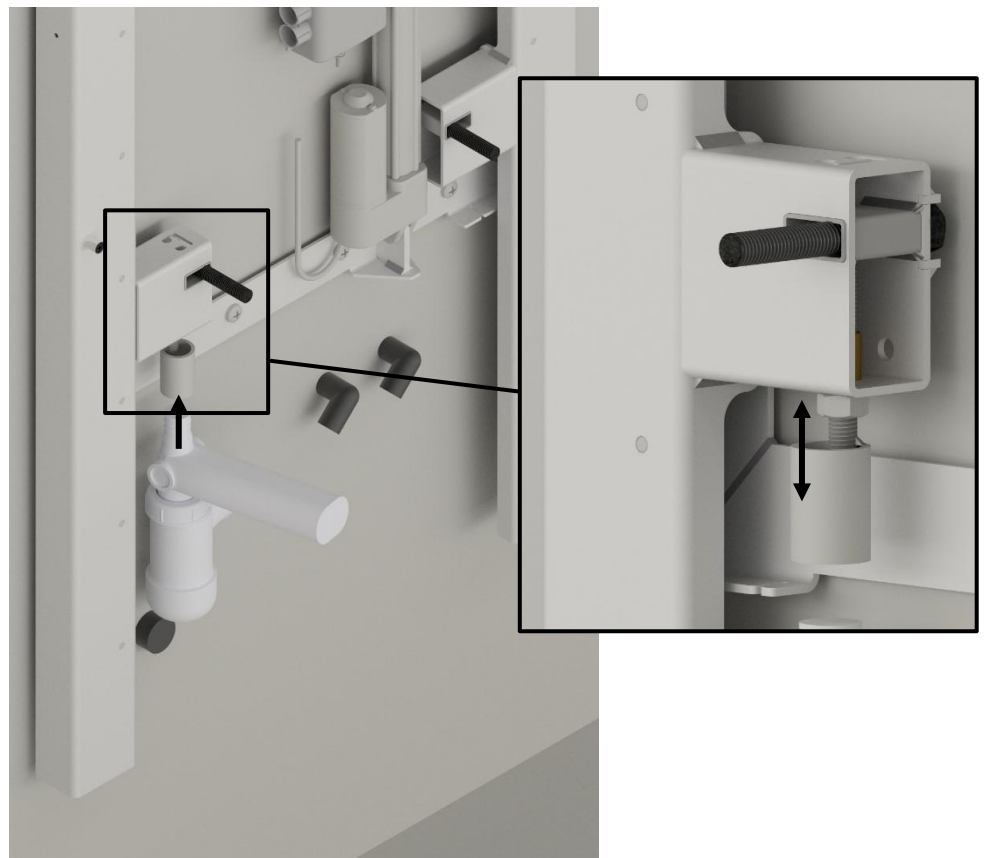

Install the siphon. Adjust the holder bracket according to the washbasin to be mounted. The height of the bracket depends on the height of the washbasin.

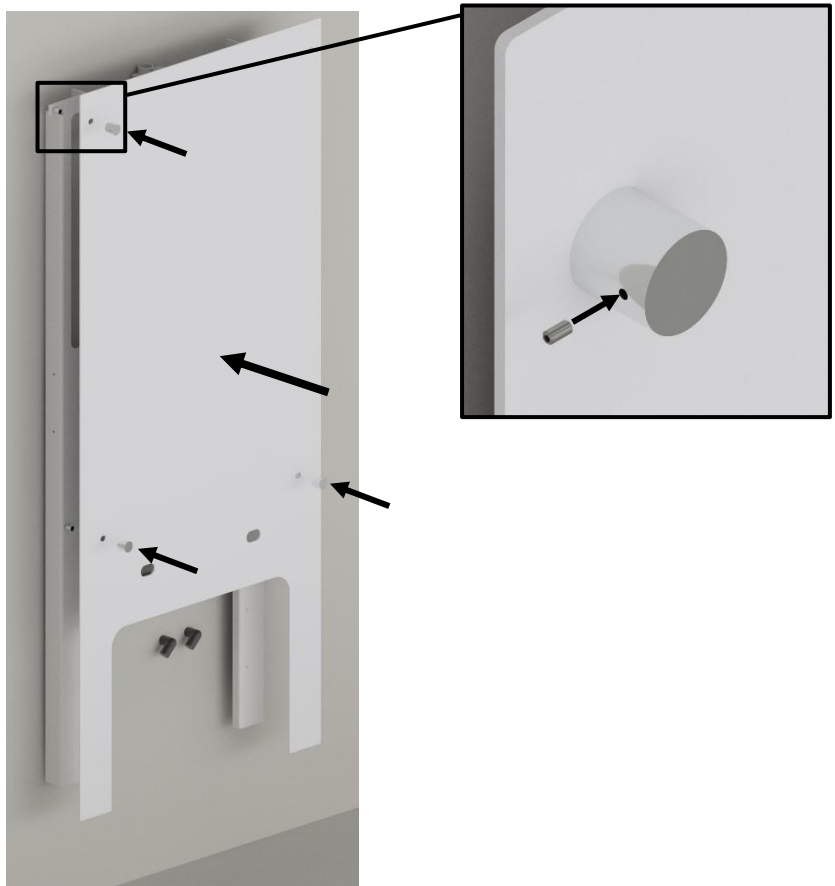

Mount the flat cover and 3 (three) mirror brackets so it is kept in.



Mount the washbasin with the enclosed mounting parts for bolt mounted washbasins. Likewise, mount the mixer tap, but wait until later with mounting the hoses.



Remove the protective foil from the double-coated tape on the back of the brackets for the installation cover.

It is now pushed in place so that the brackets glue to the wall.



Remove the installation cover and push the brackets very firmly against the wall to make sure that the glue has good contact with the wall.

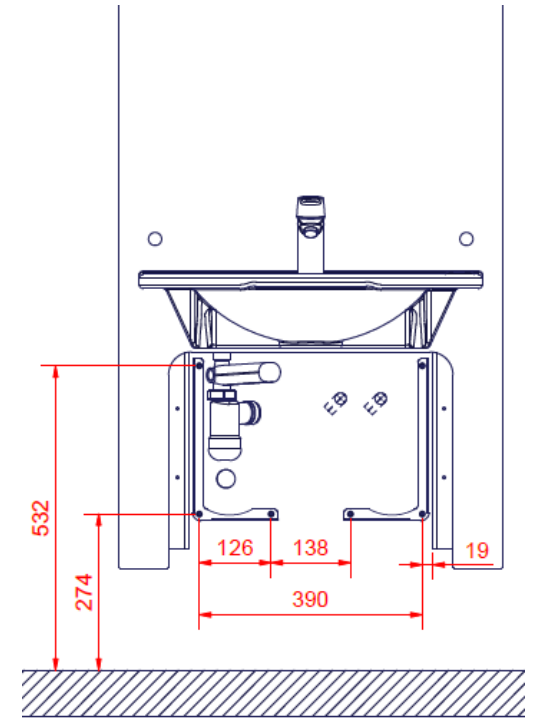

Alternatively, the brackets can be screwed to the wall.  
Use the shown measurements (mm).



The power connection is positioned in a radius of up to 1500mm

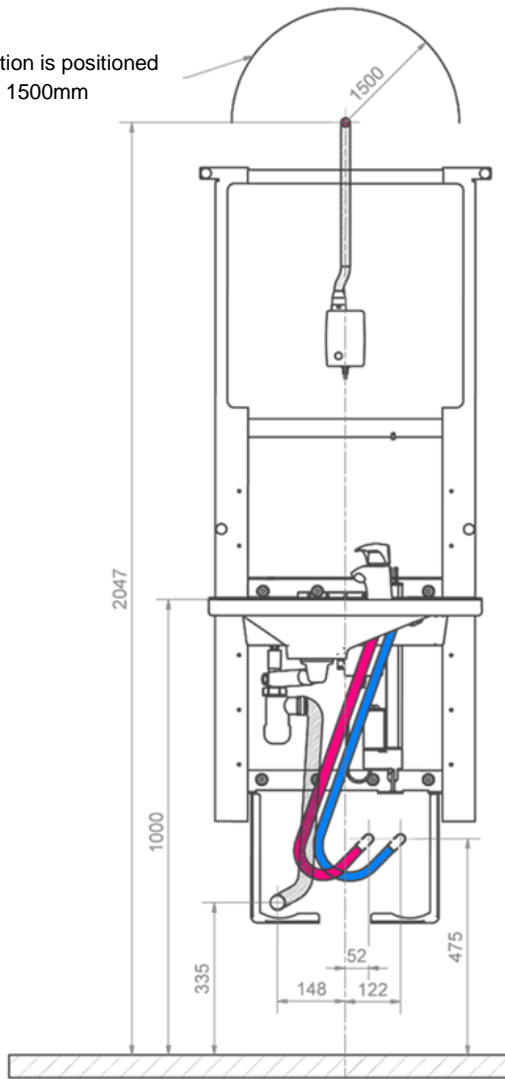

Install water connection and drain hoses as illustrated. Re-mount the installation cover by attaching the Velcro to the brackets. Make sure that all hoses move freely and unhindered.

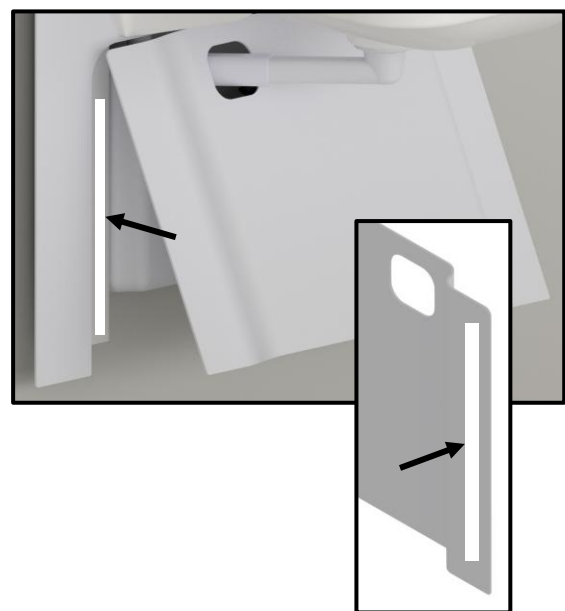

Cut the Velcro strips into two pieces, then remove the protective paper from the back. One side of the Velcro attaches to the metal frame, the other to the outer cover. Mount the outer cover as shown.



Install the rest of the drain and screw it in the washbasin.  
Now check that the washbasin and hoses below the caps move freely by moving the lifting unit up and down.

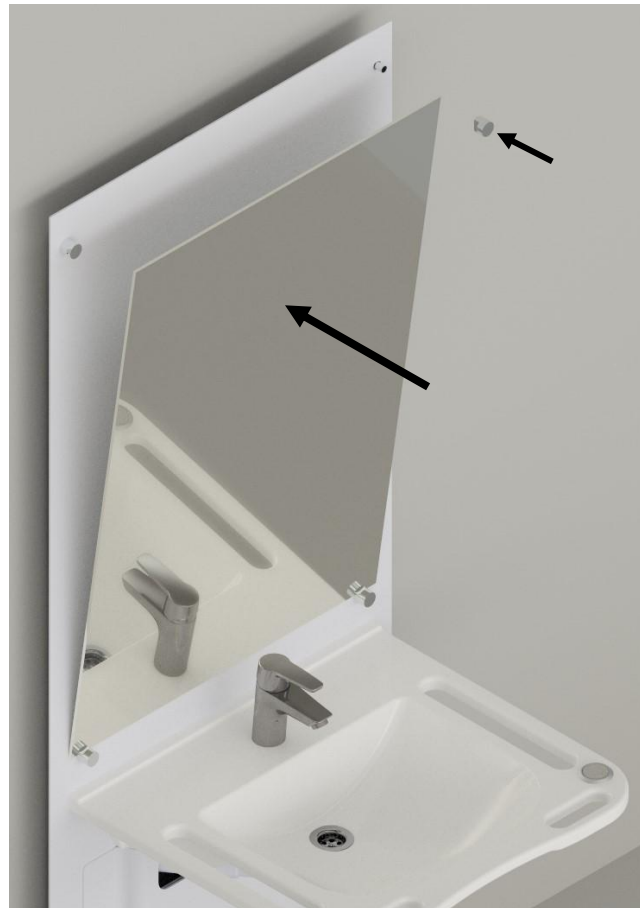

Remove the protective foil on the double-coated tape on the back of the mirror and fix it as illustrated. Press it firmly and make sure that the mirror is properly fastened so that the final mirror bracket can be mounted.

### 4.6.1 Functionality test

After installation has been completed, and before putting the product into use, it's important to test the functionality of the Ropox SlimLine. Afterwards, it's important to conduct the same functionality test once a year to ensure continued safe use. This must be done by qualified persons only.

1. Check that the mounting instructions have been properly followed.
2. Check that all the nuts/bolt/screws are properly fastened.
3. Check that the plumbing is connected properly and doesn't leak.
4. Make sure the frame is not under external stress, such as colliding with objects.
5. Make sure the frame and washbasin doesn't collide with anything during travel. Do a full travel of the frame to ensure proper function, and check for colliding objects.

Afterwards, the Ropox SlimLine can be put into use. Before the first use, read section 6 Safety in Use.

### 4.7 Cable diagrams

Standard product with remote control.

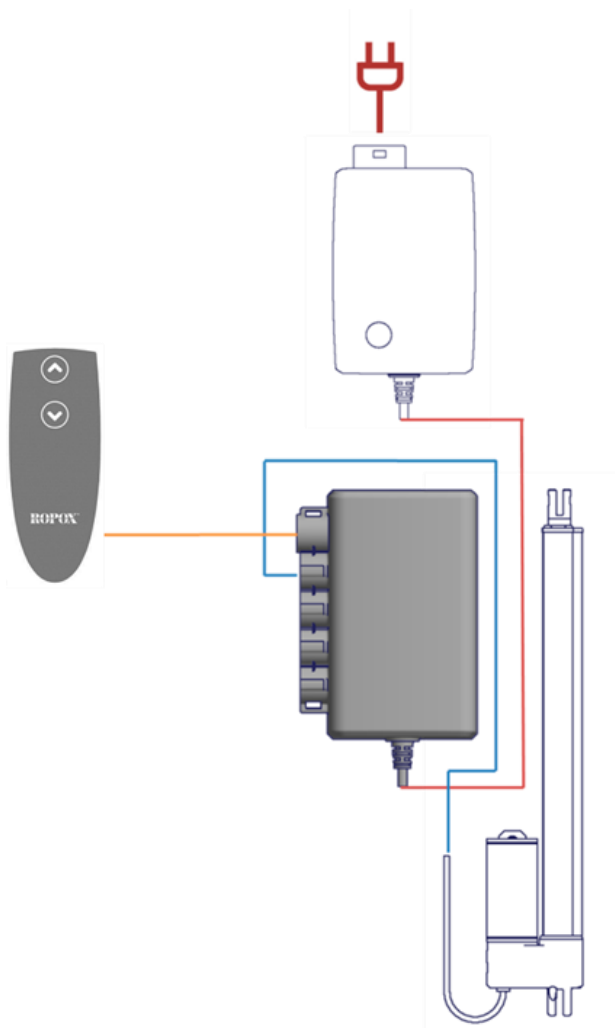

Product with fixed control and handheld control. Here, a split cable is used.

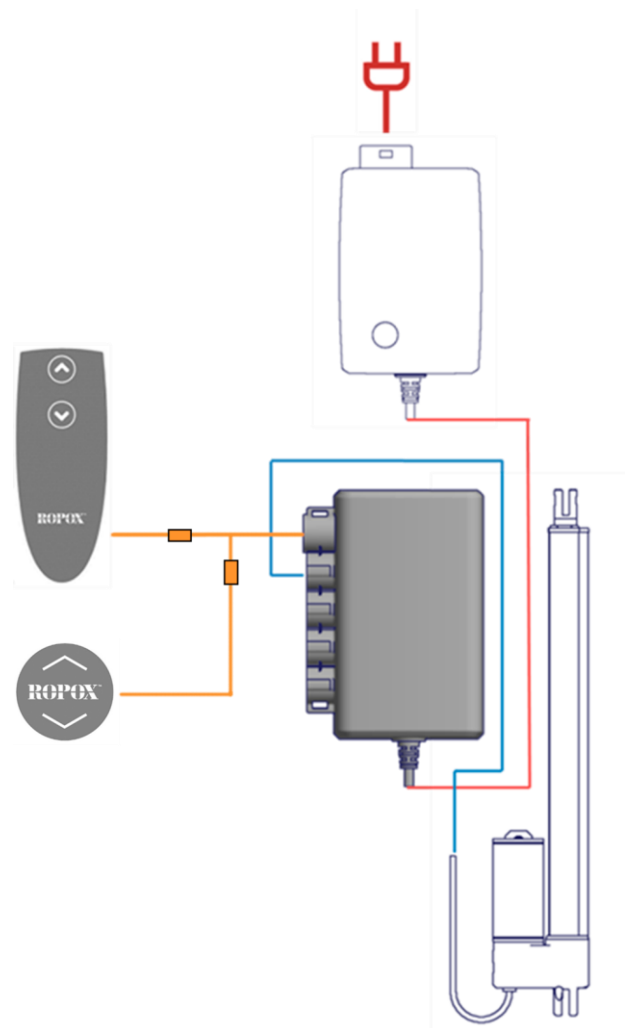

## 5. Trouble shooting

Problem	Solution
The washbasin does not move up or down when pressing the hand control.	Check if: <ul style="list-style-type: none"> <li>➤ 230 V is connected, and if the power is on.</li> <li>➤ The engine is connected to the control box.</li> <li>➤ The control is connected to the control box.</li> <li>➤ The engine is overloaded. (NOTE: For every 2 minutes of use, it needs 18 minutes of rest).</li> </ul>
Hand control is defect.	Check if: <ul style="list-style-type: none"> <li>➤ The washbasin can be height adjusted by means of another control.</li> </ul>
When pressing the UP and DOWN buttons, only "click" sounds come out of the control box – no movement.	<ul style="list-style-type: none"> <li>➤ The plug may not be mounted correctly.</li> <li>➤ Remove all cables from the control box, and mount again.</li> <li>➤ Maybe a "Reset" is needed. See the instructions below.</li> </ul>
The frame seems loose and unstable.	<ul style="list-style-type: none"> <li>➤ Tighten all screws of the frame, cf. the mounting instructions.</li> </ul>
The washbasin cannot be height adjusted, or the height adjustment feels very difficult.	<ul style="list-style-type: none"> <li>➤ Check that there are no jammed objects preventing the height adjustment.</li> </ul>
It takes too long for the water to leave the washbasin.	<ul style="list-style-type: none"> <li>➤ Check the siphon for clogging and clean it, if required.</li> <li>➤ Check that the flexible hose has not been positioned so high on the wall that it acts as an additional siphon.</li> <li>➤ Check that connection hoses are not kinked or twisted on the hose. Adjust the hoses so that they are not kinked/twisted.</li> </ul>

**Reset:** Press and hold the UP (▲) and DOWN (▼) buttons at the same time. Keep the buttons depressed for approx. 10 seconds. Now move the frame to bottom position for resetting.

## 6. Safety in use

- Always use the washbasin in a manner excluding the risk of damage to people or property. The person operating the SlimLine washbasin is responsible for avoiding damage or injury.
- The SlimLine washbasin is a height adjustable washbasin and may not be used as a lifting table or as a person lifter.
- Always check the water temperature before use. Too warm water may lead to scalding.
- If a handcontrol with flexible cord has been installed, be aware of the cord not getting caught on anything. This could lead to a tripping hazard.
- Make sure that there is free space above and below the washbasin to allow free height adjustment.
- Be aware of water splashing from the washbasin during use, or actuation of the height adjustment. A wet floor will result in a slipping hazard.
- Prior to use, ensure that the SlimLine washbasin has been mounted on a suitably strong wall and that there are no loose connections.
- Make sure that there are no people under the SlimLine when adjusting the height
- Do not overload the washbasin and make sure that the load distribution is correct.
- Do not operate the washbasin in case of errors or damage.
- Do not use the washbasin in an explosive environment.
- If covers are removed there is a risk that a person can place fingers/hands between moving parts (actuator) and fixed parts (metal frame).
- If the mirror breaks or falls out of the holders, then a person may be hit by sharp, broken parts.
- If the washbasin is used in publicly accessible locations, where especially children or other persons with reduced observation capability may get near the SlimLine washbasin, the person operating the washbasin must pay sufficient attention in order to prevent dangerous situations.
- Any modification to the SlimLine washbasin, which may influence its operation and construction, is forbidden.
- Installation, service, and repairs may only be conducted by qualified personnel.
- If the SlimLine washbasin has not been installed in accordance with these mounting instructions, the warranty may be void.
- Only use original Ropox spare parts as replacements parts. If other parts are used, the warranty may be void.

# 7. Cleaning

Ropox SlimLine may be wiped with a wrung cloth with lukewarm water and a mild detergent. Do not use corrosive/grinding fluids or scouring sponges.

	<b>Note!</b>
	Do not use cleaning agents containing abrasive e.g. scouring powder, steel wool, scouring sponge.  This product is not designed to be sterilized, autoclaving and sterilization beyond normal cleaning is may possibly change the product safety and function.

## 7.1 Preapproved cleaning agents

Tradename	Solution
Acticlor plus	1000ppm
S90 sanirens	1-3% peracid
FUTUR, Alkalisk rens	1% solution [pH 9,5]

# 8. Maintenance

	<b>Note!</b>
	Failing to comply with periodic maintenance may result of degrading of product function and safety. Inspections, service and repairs must be carried out by competent personnel.

The frame of the Ropox Slimline Electric is maintenance-free. Moving parts have been lubricated for life. For reasons of safety and reliability, we recommend inspection of the frame once a year.

## 8.1 Performance test

### After one month

Check:

Mounting of fixtures

The connection of the flexible hoses – water supply and drain

### Once a year

Move the washbasin to top position and check:

- That all screws and bolts are fixed.
- That the frame can move freely and unhindered from bottom to top position without problems.
- That water connection hoses and drain hoses are tight and functional and able to move unhindered.
- Press the DOWN (▼) button, move the frame to bottom position and check that the movement is even and smooth. Make sure that the hose connections follow the movements of the frame, and that they do not get squeezed.
- Now press the UP (▲) button, move the frame to top position and check that the movement is even and smooth. Make sure that the hose connections follow the movements of the frame, and that they do not get squeezed.

After each inspection, the service schedule must be completed. See section 8.2.

	<b>Note!</b>
	Only use original Ropox spare parts as replacement parts. If other parts are used, the warranty may be void.

## 8.2 Service schedule

<b>Service and maintenance</b> <b>Serial no.</b>
<b>Date:</b> _____
<b>Signature:</b> _____
<b>Remarks:</b> _____ _____ _____

<b>Service and maintenance</b> <b>Serial no.</b>
<b>Date:</b> _____
<b>Signature:</b> _____
<b>Remarks:</b> _____ _____ _____

<b>Service and maintenance</b> <b>Serial no.</b>
<b>Date:</b> _____
<b>Signature:</b> _____
<b>Remarks:</b> _____ _____ _____

<b>Service and maintenance</b> <b>Serial no.</b>
<b>Date:</b> _____
<b>Signature:</b> _____
<b>Remarks:</b> _____ _____ _____

<b>Service and maintenance</b> <b>Serial no.</b>
<b>Date:</b> _____
<b>Signature:</b> _____
<b>Remarks:</b> _____ _____ _____

<b>Service and maintenance</b> <b>Serial no.</b>
<b>Date:</b> _____
<b>Signature:</b> _____
<b>Remarks:</b> _____ _____ _____

<b>Service and maintenance</b> <b>Serial no.</b>
<b>Date:</b> _____
<b>Signature:</b> _____
<b>Remarks:</b> _____ _____ _____

<b>Service and maintenance</b> <b>Serial no.</b>
<b>Date:</b> _____
<b>Signature:</b> _____
<b>Remarks:</b> _____ _____ _____

## 9. Spare parts list



### Note!

Ropox will make parts list available for extraordinary maintenance and repair beyond what is described in this manual. Repair beyond what is described in this manual may only be done by Ropox designated service personnel.

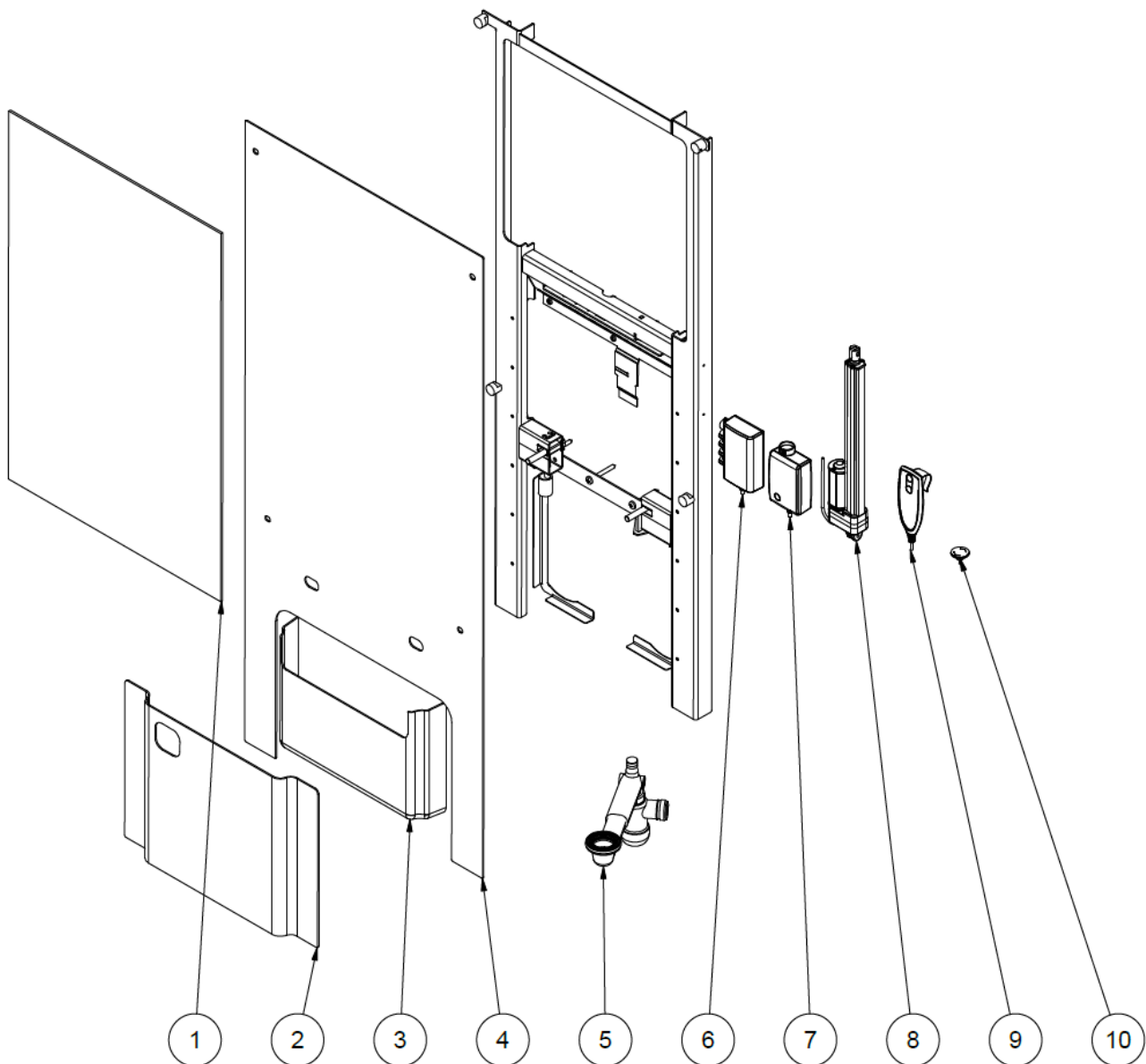

Position	Description	Number in product	Item no.
1	Mirror 600x900x5	1	97002455
2	Bottom cover	1	40*15601-096
3	Installation cover	1	40-15610
4	Top cover	1	40*15601-097
5	Plumbing kit for SlimLine	1	40-15612
6	Control box	1	97002672
7	Power supply	1	97002679
8	Actuator	1	97002671
9	Remote control with cable	1	97002689
10	Fixed control (Accessory)	1	97002674

# 10. Environmental protection

The product is not intended to be disposed as municipal waste. Proper disassembly, sorting and disposal of components must be done by waste disposal professionals.



Part	Disposal recommendation
Wash basin	Ceramic
Main unit	Steel
Faucet	Steel
Cover	Plastic
Actuator	Electronic
Control box	Electronic

# 11. Electromagnetic compatibility

## 11.1 Suitable Environments

The device is suitable for use at home, at daycare centers, at day centers for persons with physical or mental disabilities or at hospitals except near active HF surgical equipment and the RF shielded room of a medical electrical system for magnetic resonance imaging, where the intensity of electromagnetic disturbances is high.

## 11.2 Adjacent and stacked use

	<p><b>Warning!</b></p> <p>Use of this equipment adjacent to or stacked with other equipment should be voided because it could result in improper operation. If such use is necessary, this equipment and the other equipment should be observed to verify that they are operating normally</p>
--	--

## 11.3 Cables

Cable component	Length
Power cable	3,2m
Hand control spiral cable	Approx. 90cm extended.

	<p><b>Warning!</b></p> <p>Use of accessories, transducers, and cables other than those specified or provided by the manufacturer of this could result in increased electromagnetic emissions or decreased electromagnetic immunity of this equipment and result in improper operation.</p>
--	--

## 11.4 RF portable equipment

	<p><b>Warning!</b></p> <p>Portable RF communications equipment (including peripherals such as antenna cables and external antennas) should be used no closer than 30 cm (12 inches) to any part of the device, including cables specified by the manufacturer. Otherwise, degradation of the performance of this equipment could result.</p>
--	--



# 12. Complaints

See General Terms of Sale and Delivery on [www.ropox.com](http://www.ropox.com)

**UK  
CA**

**CE**

**ROPOX A/S**

Ringstedgade 221

DK – 4700 Næstved

Tel.: +45 55 75 05 00 Fax.: +45 55 75 05 50

E-mail: [info@ropox.dk](mailto:info@ropox.dk)

[www.ropox.com](http://www.ropox.com)